

**The Wilkinsburg-Penn Joint Water Authority**

**2200 Robinson Boulevard**

**Pittsburgh, PA 15221**

**412-243-6200 Fax 412-243-5837**

**Specifications for Fire Lines  
With Hydrants 4" and Larger**

**412-243-6200 Customer Service**

**412-243-6180 John Baurle**

**412-243-6184 Taylor Kasabian**

## **REGULATIONS FOR NEW, REPLACED AND REPAIRED SERVICE LINES 4" AND LARGER**

- 1) A \$200.00 estimate fee and building plans must be submitted to the Authority for new service lines.
- 2) A service line location must be given by Authority personnel for new service lines after a footer or foundation has been installed.
- 3) Service lines over 100' in length must have a meter vault.
- 4) All service lines shall be installed from inside the building or vault out to the curb line or main line.
- 5) All service lines shall be installed at a depth of 54"
- 6) When a service line runs under apportion of the building, a minimum depth of 18" will be required.
- 7) All service lines must be at right angles to the street (90°)
- 8) All joints and fittings must be restrained by use of Field-Loc gaskets, Meg-a-lugs, and or thrust blocking.
- 9) All service lines must be inspected in the **open trench** by Authority personnel. Pictures or video of installed service lines are not acceptable.
- 10) A hydrostatic test must be performed from the curb valve to the inlet valve at 1.5 times the actual pressure and maintained for 1 hour. This test will be conducted by the installation contractor and witnessed by an Authority Representative.
- 11) Requests for service line inspections must be received by the Authority office prior to 11:00AM on the date of the requested inspection. Requests received after 11:00AM shall be referred to the next business day.
- 12) All charges must be paid and inspections completed before the main will be tapped and the service line between main and curb will be installed.
- 13) The Allegheny County Plumbing inspector must be contacted for inspection.

### **MATERIAL SPECIFICATIONS**

#### **PIPE:**

Ductile iron, centrifugal cast and shall comply in all respects to ANSI Specifications A21.51, Thickness Class 52 with push-on joints. All pipe shall be cement mortar lined. 1/8 inch (double thickness) on the inside and coal tar coated on the outside, lining and coating to comply with ANSI Specifications A21.50.

#### **FITTINGS:**

All fittings shall be cast from ductile iron in accordance with ANSI/AWWA C153/A21.53 with mechanical joint bells. Glands, bolts, nuts and gaskets shall be in accordance with requirements of ANSI/AWWA C153/A21.53. The working pressure rating shall be 350 PSI. All fittings shall be cement mortar lined. Fittings shall have an asphaltic outside coating in accordance with ANSI/AWWA C153/A21.53. Fittings may be compact or full body types.

If you have questions, please contact the Wilksburg-Penn Joint Water Authority offices.

# Hydrostatic Pressure Testing

## Overview:

Hydrostatic pressure tests are used to gauge the integrity of a pipeline following its construction or repair activities that could affect its leak-tightness. As the term implies, in hydrostatic testing of new or repaired pipelines, water in the line is pressurized beyond the maximum operating pressure, and then maintained for a predetermined amount of time to determine if there are any leaks. The operational integrity of connections and the pipe itself is assured if the hydrostatic test is successfully passed.

## Testing:

The Contractor shall conduct the test. The pump, pipe connections, gauges and all necessary apparatus shall be furnished by the Contractor. The pipe shall be slowly filled with water. All air shall be expelled from the pipe as the line is filled. The line is pressurized to 1.5 times the actual pressure for a predetermined amount of time with zero pressure loss. A Water Authority Representative must witness the test. Lines, which fail to meet test requirements, shall be repaired and retested as necessary until test requirements are complied with. All pipe, fittings and other materials found to be defective under the test shall be repaired or replaced at the Contractor 's expense.

# THE WILKINSBURG-PENN JOINT WATER AUTHORITY

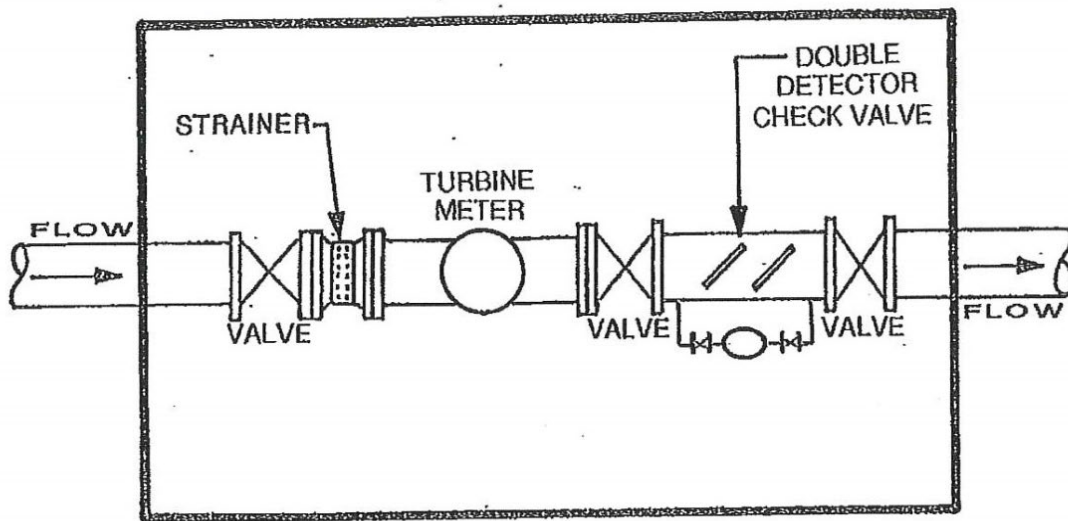

TURBINE METER VAULT

## Meter Vault

- 1) Size
  - a) Minimum size of vault will be 6' x 6' x 6' Depth
  - b) The size of the service line /fire line, meter type and backflow preventer will determine the vault dimensions
- 2) Vault opening:
  - a) Minimum 48" x 48" Double leaf Access Hatch
  - b) The placement of the vault i.e. Grass, sidewalk, road will determine Grade of hatch necessary.
- 3) Provisions for drainage or sump pump.
- 4) Ladder or steps:
  - a) Directly under vault opening.
  - b) Must be safe and convenient for entry.
- 5) Consumer to maintain vault in a safe and sanitary condition at all times.

## Meter Room

- 1) Must have a permanent heat source.
- 2) Minimum of 6'-6" head clearance.
- 3) Provisions for drainage or sump pump.
- 4) Provide lighting.
- 5) Be easily accessible.
- 5) Consumer to maintain room in a safe and sanitary condition at all times.
- 6) The size of the service line, meter type and backflow preventer will determine the meter room dimensions

### DOMESTIC SERVICE

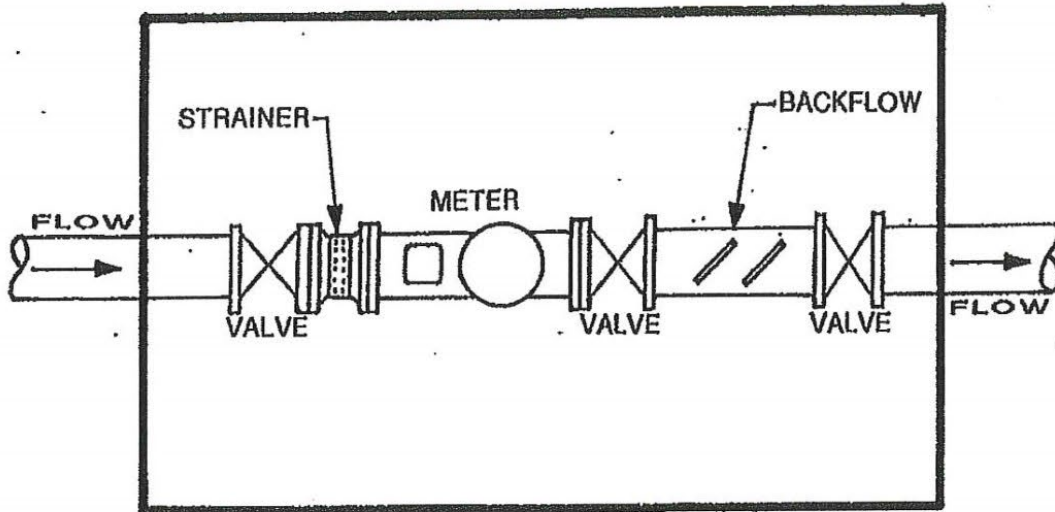

COMPOUND METER VAULT

\*\*\*\*\*

### FIRE SERVICE

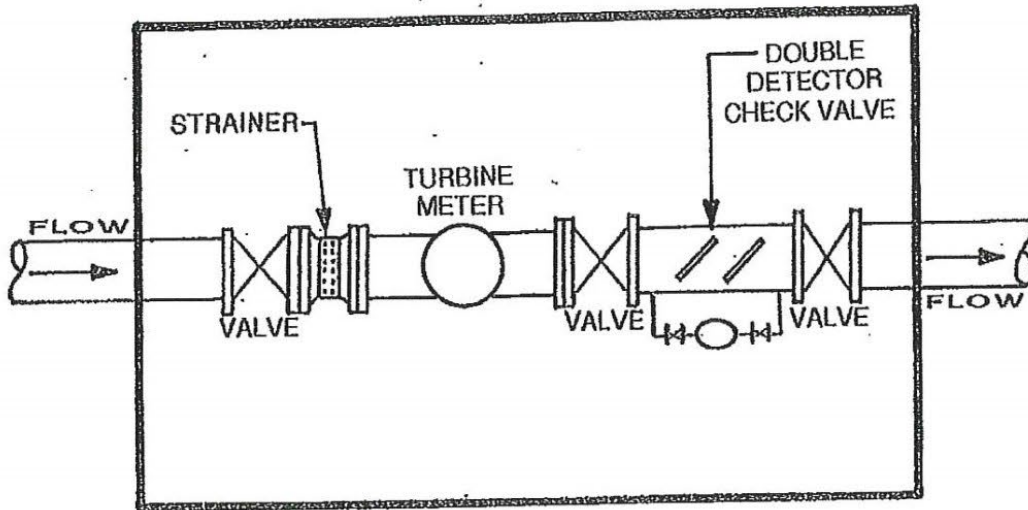

TURBINE METER VAULT

Note: Domestic and Fire may be installed in separate vaults or combined in one vault but each service must have its own tap in the water main

# HIGH PERFORMANCE TURBINE METER

SIZES: 1½", 2", 3", 4", 6", 8", and 10"



High Performance (HP) Turbine water meters offer some of the widest flow ranges of any turbine meters on the market.

All HP Turbine water meters meet or exceed the latest performance and accuracy requirements of AWWA C701 and maximum continuous flow rates may be exceeded by as much as 25% for intermittent periods.

Each HP Turbine consists of a rugged, lead free, high-copper alloy maincase, an AWWA Class II turbine measuring element, and a roll-sealed register. The maincase is corrosion-resistant, lightweight, and compact. Inlet and outlet connections are flanged. Strainers are available to prevent debris from entering the meter and to reduce the effects of uneven water flow due to upstream piping variations.

The unitized measuring element (UME) allows for quick, easy, in-line interchangeability. Water volume is measured accurately at all flows by a specially-designed assembly. The hydrodynamically-balanced, thrust-compensated rotor relieves pressure on the thrust bearings to minimize wear and provide sustained accuracy over an extended operating life. Direct coupling of the rotor to the gear train eliminates revenue loss due to slippage during fast starts and line surges. A calibration vane allows in-field calibration of the UME to lengthen service life and to ensure accurate registration.

The roll-sealed register eliminates leaking and fogging. A magnetic drive couples the register with the measuring element.

The HP Turbine water meter is designed for applications where flow rates are consistently moderate to high.

Adaptability to all present and future systems for flexibility.

CONSTRUCTION

APPLICATION

SYSTEMS COMPATIBILITY

KEY FEATURES

- Roll-Sealed Register
  - Magnetic drive, low-torque registration ensures accuracy
  - Impact-resistant register design with flat glass for readability
  - 1:1 ratio, low-flow indicator identifies leaks
  - Bayonet mount allows in-line serviceability
  - Tamperproof seal pin deters theft
  - Date of manufacture, size, and model stamped on dial face
  
- Lead Free Maincase
  - Made from lead free, high-copper alloy
  - NSF/ANSI 61 and 372 certified
  - Compact design is lightweight and easy to handle
  - Sturdy, durable, corrosion-resistant
  - Resists internal pressure stresses and external damage
  - Residual value
  
- Turbine Measuring Element
  - Excellent low-flow sensitivity and wide flow ranges available at 98.5% - 101.5% accuracy
  - Direct coupling of rotor to gear train prevents slippage and ensures accurate registration
  - Interchangeable measuring element allows for in-line service
  - Hydrodynamically-balanced rotor
  - Reusable O-ring gasket on 3" - 10" sizes

WARRANTY

Neptune provides a limited warranty with respect to its HP Turbine water meters for performance, materials, and workmanship.

When desired, owner maintenance is easily accomplished by in-line replacement of major components.

## 1½" ACCURACY

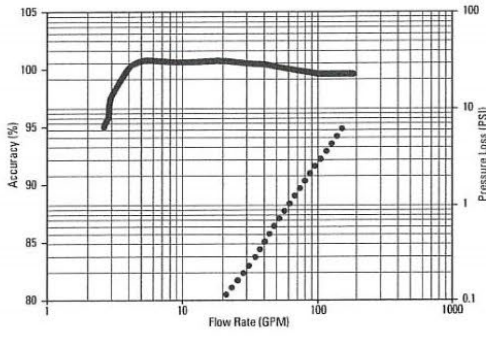

## 2" ACCURACY

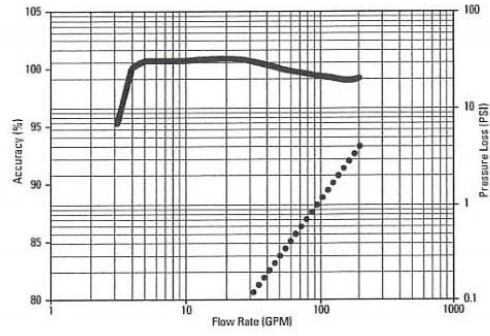

## 3" ACCURACY

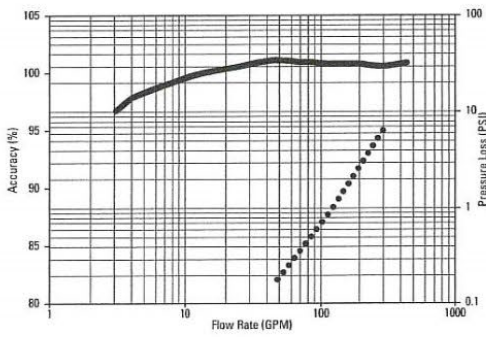

## 4" ACCURACY

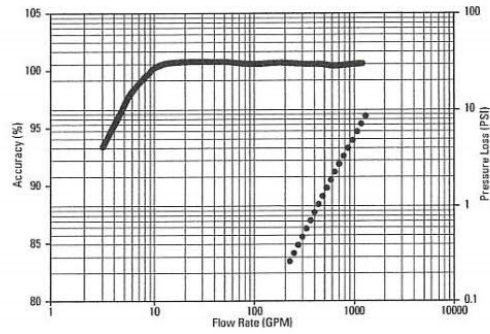

## 6" ACCURACY

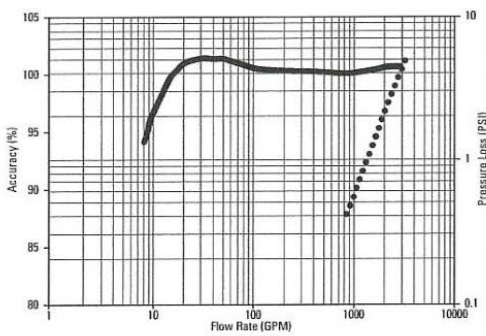

## 8" ACCURACY

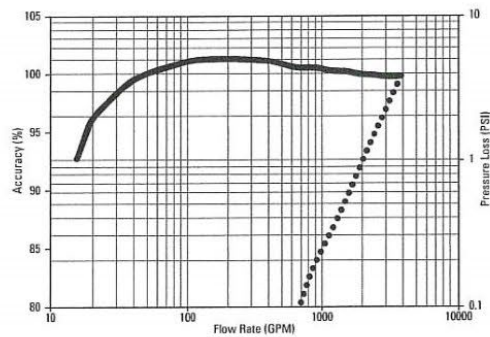

## 10" ACCURACY

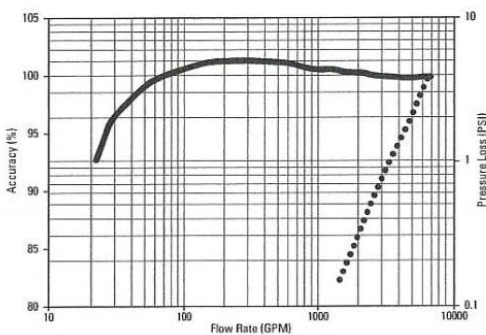

— Accuracy  
 ..... Head Loss

*These charts show typical meter performance. Individual results may vary.*

## OPERATING CHARACTERISTICS

Meter Size	Normal Operating Range @100% Accuracy (±1.5%)	Maximum Intermittent Flow	AWWA Standard
1½"	4 to 160 US gpm 0.91 to 36.3 m³/h	200 US gpm 45.4 m³/h	4 to 120 US gpm 0.91 to 27.3 m³/h
2"	4 to 200 US gpm 0.91 to 45.4 m³/h	250 US gpm 56.8 m³/h	4 to 190 US gpm 0.91 to 43.2 m³/h
3"	5 to 450 US gpm 1.14 to 102.2 m³/h	560 US gpm 127.2 m³/h	8 to 435 US gpm 1.8 to 98.8 m³/h
4"	10 to 1200 US gpm 2.27 to 272.5 m³/h	1500 US gpm 340.7 m³/h	15 to 750 US gpm 3.4 to 170.3 m³/h
6"	20 to 2500 US gpm 4.55 to 567.8 m³/h	3100 US gpm 704.1 m³/h	30 to 1350 US gpm 6.8 to 306.6 m³/h
8"	35 to 4000 US gpm 7.95 to 908.5 m³/h	5000 US gpm 1135.6 m³/h	50 to 2800 US gpm 11.4 to 635.9 m³/h
10"	50 to 6500 US gpm 11.36 to 1476.3 m³/h	8000 US gpm 1817 m³/h	75 to 4200 US gpm 17.0 to 953.9 m³/h

## DIMENSIONS

Meter Size	A	B	C-STD	C-ProRead™	C-CODER®R9007™ and E-CODER®R4507™	D	E	F	G	Weight
	in (mm)	in (mm)	in (mm)	in (mm)	in (mm)	in (mm)	in (mm)	in (mm)	in (mm)	lbs (kg)
1½"	10 (254)	6½ (165)	7⅙ (181)	7⅞ (192)	7¾ (197)	1¼ (44)	¾ (19)	4½ (114)	5⅞ (137)	19 (8.6)
2"	10 (254)	6½ (165)	7⅝ (194)	8⅞ (204.8)	8¼ (210)	2⅞ (54)	1⅜ (21)	4½ (114)	5⅞ (137)	20 (9.1)
3"	12 (305)	6 (152)	10 (254)	10⅞ (265.1)	10⅝ (270)	3¾ (95)	⅝ (16)	6¼ (159)	7½ (191)	40 (18.1)
4"	14 (356)	6½ (165)	10⅞ (276)	11⅝ (287.3)	11½ (292)	4½ (114)	¾ (19)	8⅞ (206)	9 (229)	52 (23.6)
6"	18 (457)	8⅝ (219)	13 (330)	13⅞ (341.3)	13⅝ (346)	5½ (140)	1 (25)	10¼ (260)	11 (279)	115 (52.2)
8"	20 (508)	9⅝ (244)	15½ (394)	15⅝ (404.8)	16⅞ (409)	6¾ (171)	1⅞ (29)	10¼ (260)	13½ (343)	195 (88.4)
10"	26 (660)	12⅝ (321)	15½ (394)	15⅝ (404.8)	16⅞ (409)	8 (203)	1¼ (32)	10¼ (260)	16 (406)	275 (124.7)

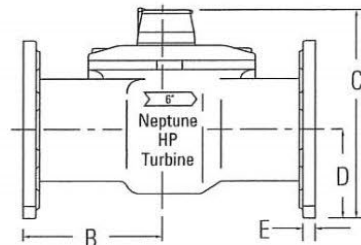
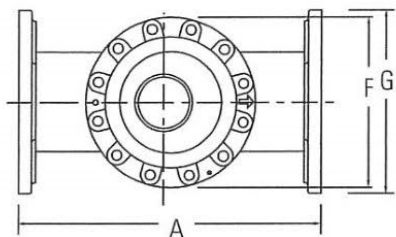

## GUARANTEED SYSTEMS COMPATIBILITY

All HP Turbine water meters are guaranteed adaptable to our ARB® V, ProRead™ (ARB VI), E-CODER®)R900i™, E-CODER®)R450i™, E-CODER®, TRICON®/S, TRICON/E®3, and Neptune meter reading systems without removing the meter from service.

## REGISTRATION

Registration (per sweep hand revolution)		
	1½", 2", 3", 4"	6", 8", 10"
1,000 US Gallons		✓
1,000 Imperial Gallons		✓
100 US Gallons	✓	
100 Imperial Gallons	✓	
100 Cubic Feet		✓
10 Cubic Feet	✓	
10 Cubic Metres		✓
1 Cubic Metre	✓	

Register Capacity (6-wheel odometer)		
	1½", 2", 3", 4"	6", 8", 10"
1,000,000,000 US Gallons		✓
1,000,000,000 Imperial Gallons		✓
100,000,000 US Gallons	✓	
100,000,000 Imperial Gallons	✓	
100,000,000 Cubic Feet		✓
10,000,000 Cubic Feet	✓	
10,000,000 Cubic Metres		✓
1,000,000 Cubic Metres	✓	

### SPECIFICATIONS

- Application: cold water measurement of flow in one direction
- Maximum operating pressure: 175 psi (1206 kPa)
- Maximum operating temperature: 80°F
- Register: direct reading, center-sweep, roll-sealed, magnetic drive with low-flow indicator
- Measuring element: AWWA Class II Turbine, hydrodynamically-balanced rotor

### OPTIONS

- Sizes: 1½", 2", 3", 4", 6", 8", 10"
- Units of measure: U.S. gallons, imperial gallons, cubic feet, cubic metres
- Register Types:
  - Remote reading systems\*: ARB V, ProRead, E-CODER)R900i; E-CODER)R450i; E-CODER, TRICON/S, TRICON/E3
  - Reclaim
- Companion flanges:
  - 1½" and 2" (oval): bronze
  - 3", 4", 6": bronze or cast iron
  - 8" and 10": cast iron
- Strainer:
  - 1½" - 6" NSF/ANSI 61 lead free high copper alloy
  - 1½"-10" NSF/ANSI 61 lead free Rilsan® nylon-coated ductile iron

\* Consult factory for meter performance specifications when fitted with ARB.

Neptune Technology Group Inc.  
1600 Alabama Highway 229  
Tallahassee, AL 36078  
USA  
Tel: (800) 633-8754  
Fax: (334) 283-7293

Neptune Technology Group (Canada) Ltd.  
7275 West Credit Avenue  
Mississauga, Ontario  
L5N 5M9  
Canada  
Tel: (905) 858-4211  
Fax: (905) 858-0428

Neptune Technology Group Inc.  
Avenida Ejercito Nacional No 418  
Piso 12, Despacho 1203  
Colonia Polanco V Sección  
C.P. 11560  
Delegación, Miguel Hidalgo  
Mexico D.F.  
Tel: (525) 5203-4032 / (525) 5203-6204  
(525) 5203-5294  
Fax: (525) 5203-6503

**NEPTUNE**  
TECHNOLOGY GROUP

neptunetg.com

# Neptune® Strainers

Sizes: 2", 3", 4", 6", 8", 10", 12", 16", and 20"

## Features & Benefits

- Cast bronze body\* ensures durability and corrosion resistance
- Low head loss
- Stainless steel strainer plate and cover bolts
- Height to center line matches Neptune Turbines for easy installation
- In-line serviceability

## Application

Neptune Strainers are designed and built for long-term, trouble-free performance in water pipeline service. They are specially designed for installation with Neptune® Turbine or Tru/Flo™ Compound meters and are compatible with all other makes as well.

Schlumberger recommends that a strainer be installed with each turbine or Tru/Flo Compound meter to prevent meter damage and to ensure accurate registration regardless of the configuration of the meter installation.

\*12", 16", and 20" are epoxy-coated steel only; 8" and 10" are cast iron

## Performance

When installed at the inlet of a turbine or compound meter, the Neptune strainer performs two very important functions:

- I. It provides protection against damage to the turbine meter measuring element from debris or foreign material in the pipeline.
- II. The stainless steel, plate-type strainer element is designed to improve the velocity profile of the flow stream entering the meter. This velocity profile improvement optimizes turbine meter performance. Good metering practice normally requires 8 to 10 diameters of straight pipe at the meter inlet to minimize velocity profile distortion caused by upstream valves or other fittings. The Neptune strainer reduces this long straight-run requirement and simplifies meter installation.

## Construction

Neptune strainers are built of the highest quality, time-proven materials available for water pipeline service. Strainer bodies and covers in 2" through 6" sizes are cast bronze; 8" and 10" sizes are cast iron; and 12", 16", and 20" are epoxy-coated steel. Strainer elements and cover bolts in all sizes are stainless steel.

Neptune strainers are rated at 175 psi working pressure. Each strainer is hydrostatically tested at 300 psi before shipment to ensure hydraulic integrity.

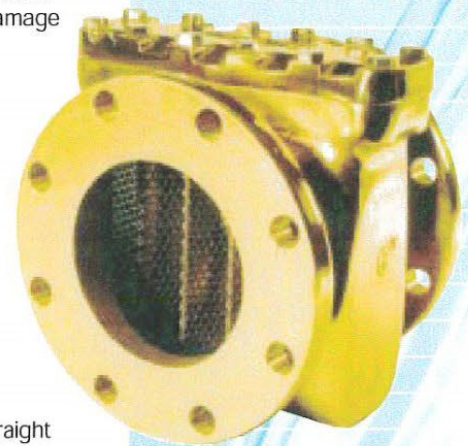

Strainers

### Warranty & Maintenance

Schlumberger provides a limited warranty with respect to its strainers for performance, materials, and workmanship.

For owner maintenance purposes, Schlumberger offers a complete inventory of replacement parts. When required, maintenance is easily accomplished without removing the strainer from the service line.

### Strainer Part Nos.

2"	53120-000	Bronze
3"	53107-000	Bronze
4"	53107-100	Bronze
6"	52000-201	Bronze
8"	52000-302	Cast Iron
10"	52000-401	Cast Iron
12"	9276-000	Steel
16"	9276-100	Steel
20"	9276-200	Steel

### Maximum Operating Pressure

175 psi

### Dimensions

Meter Size	A in/mm	B in/mm	C in/mm	D in/mm	E in/mm	F in/mm	No. of Holes	Hole Dia. in/mm	Weight lbs/kg
2"	7 178	6 152	5 1/4 133	2 1/8 54	4 1/2 114	3/4 19	2	3/4 19	16 7.3
3"	6 152	8 1/2 216	8 3/4 222	3 3/4 95	6 152	5/8 16	4	3/4 19	32 14.5
4"	7 1/2 191	9 3/4 248	10 1/2 267	4 1/2 114	7 1/2 191	11/16 17	8	3/4 19	42 19.0
6"	9 229	11 3/4 298	11 1/2 292	5 1/2 140	9 1/2 241	7/8 22	8	7/8 22	80 36.3
8"	10 254	14 356	13 1/2 343	6 3/4 171	11 3/4 298	1 1/8 29	8	7/8 22	120 54.5
10"	15 381	18 1/4 464	18 1/4 464	8 203	14 1/4 362	1 3/16 30	12	1 25	160 72.6
12"	16 7/8 429	18 7/8 479	20 1/2 521	9 1/2 241	17 432	1 3/16 21	12	1 25	180 81.6
16"	25 1/4 641	28 711	20 3/4 527	11 3/4 299	21 1/4 540	1 25	16	1 1/4 29	240 108.8
20"	18 5/8 473	28 711	26 1/8 664	13 3/4 349	25 635	1 1/8 29	20	1 1/4 32	300 136.0

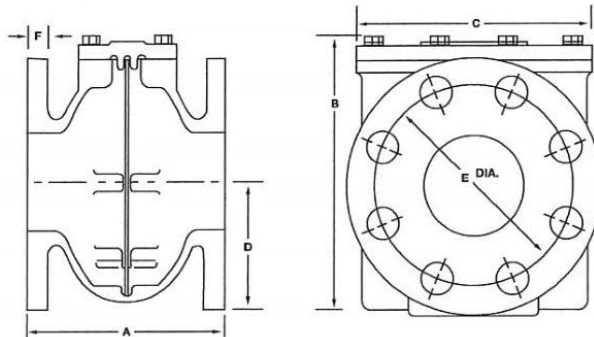

### Pressure Loss

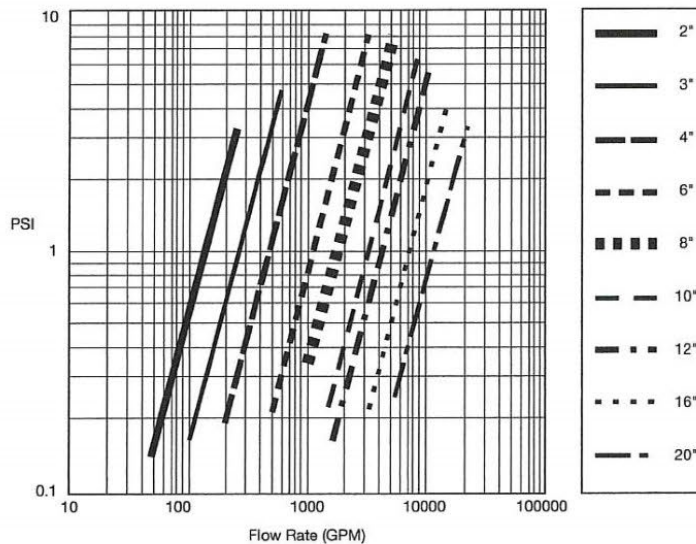

For more free information by fax, call Schlumberger Water Division, FAX-BACK System: 1-800-823-4417 and select the document you wish to order.

Customer Service/  
Direct to Factory

Your Local Schlumberger Representative:

[www.FollinFlo-Controls.com](http://www.FollinFlo-Controls.com)  
Phone: (617) 290-2134 Fax: (240) 250-8907

**Double Check  
Detector Assembly**

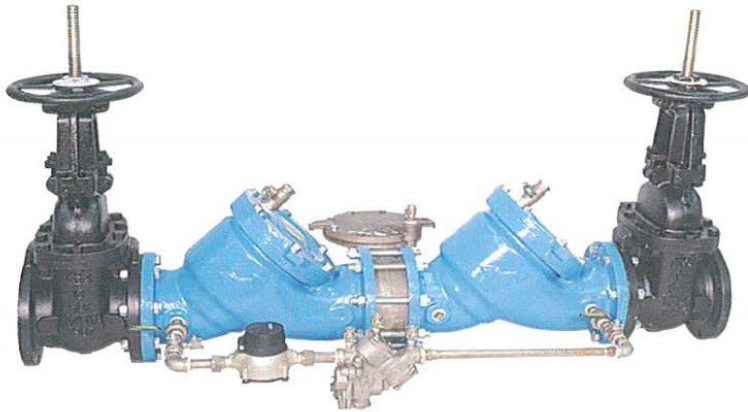
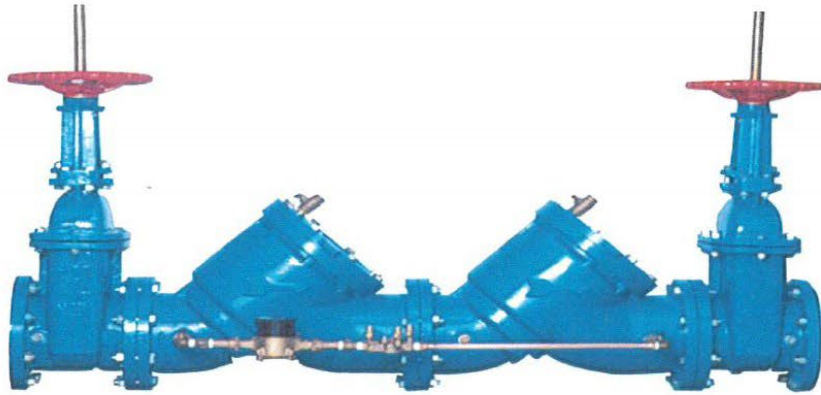

**Reduced Pressure  
Detector Assembly**

**Backflow Assemblies Must Be AWWA Approved**

## **Meter Vault**

### 7) Size

- a) Minimum size of vault will be 6' x 6' x 6' Depth
- b) The size of the service line /fire line, meter type and backflow preventer will determine the vault dimensions

### 8) Vault opening:

- c) Minimum 48" x 48" Double leaf Access Hatch
- d) The placement of the vault i.e. Grass, sidewalk, road will determine Grade of hatch necessary.

### 9) Provisions for drainage or sump pump.

### 10) Ladder or steps:

- a) Directly under vault opening.
- b) Must be safe and convenient for entry.

### 11) Consumer to maintain vault in a safe and sanitary condition at all times.

## **Meter Room**

### 6) Must have a permanent heat source.

### 7) Minimum of 6'-6" head clearance.

### 8) Provisions for drainage or sump pump.

### 9) Provide lighting.

### 10) Be easily accessible.

### 12) Consumer to maintain room in a safe and sanitary condition at all times.

### 13) The size of the service line, meter type and backflow preventer will determine the meter room dimensions